

Data sheet | Item number: 750-838/021-000  
 Controller CANopen; 640/832 KB Program/RAM; D-Sub

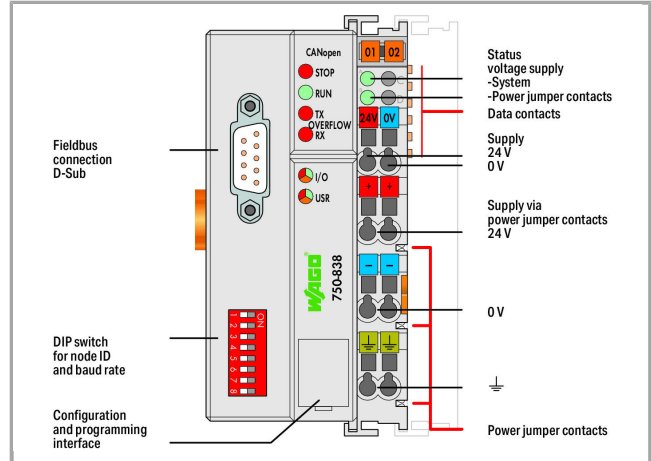

750-838/021-000



RoHS  Compliant

[BOMcheck.net](http://BOMcheck.net)

Color:

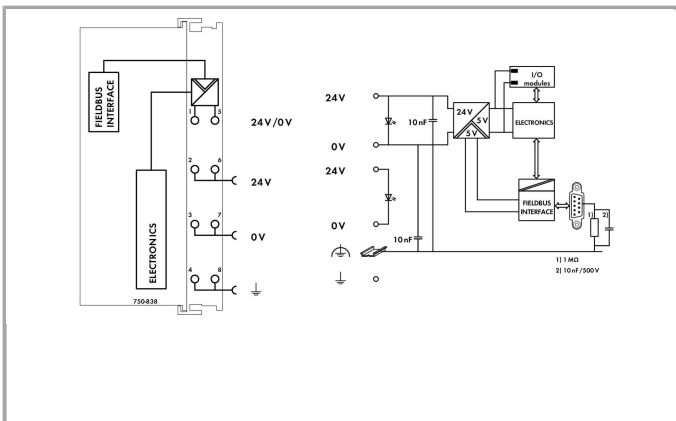

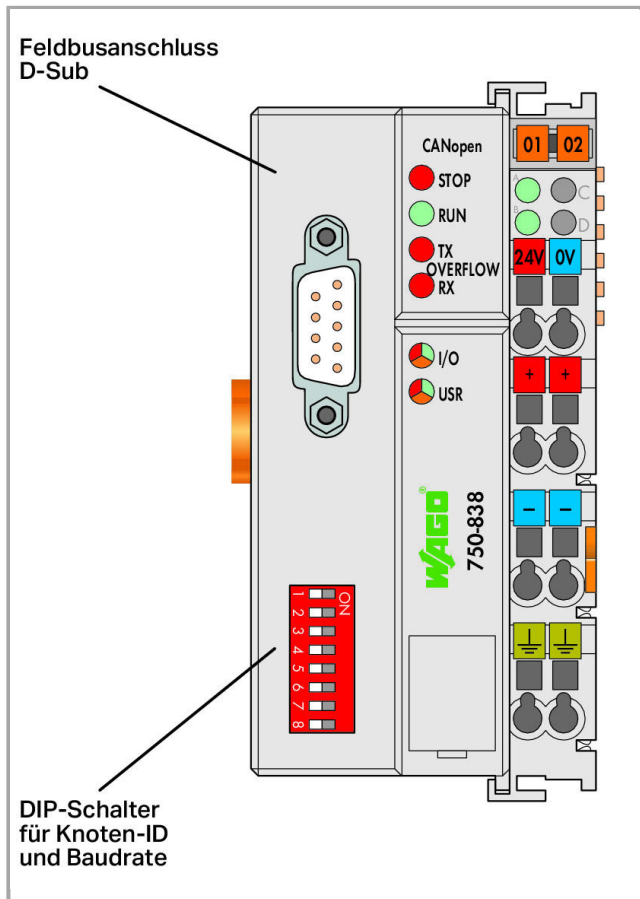

## Item description

The CANopen Controller combines control functionality, I/O interface and fieldbus in one device.

Application programming is IEC 61131-3 compliant.

The programmer can access all fieldbus and I/O data.

Features and applications:

- Decentralized control to optimize support for a PLC or PC
- Divide complex applications into individually testable units
- Programmable fault response in the event of fieldbus failure
- Signal pre-processing reduces fieldbus transmissions
- Directly control peripheral equipment for faster system response times
- Stand-alone, compact controller

**Note:**

**Note: Configuration files required (EDS)!**

The EDS files can be downloaded for free at [www.wago.com](http://www.wago.com).



## Data

## Technical Data

Communication	CANopen
Visualization	without
CPU	16 bits
Programming languages per IEC 61131-3	Instruction List (IL) Ladder Diagram (LD) Function Block Diagram (FBD), Continuous Function Chart (CFC) Structured Text (ST) Sequential Function Chart (SFC)
Programming environment	WAGO-I/O-PRO V2.3 (based on CODESYS V2.3)
Configuration options	Device description file EDS WAGO-I/O-CHECK
Cycle time	< 3 ms for 1,000 statements / 256 dig. I/Os
Baud rate	10 kBd ... 1 MBd
Fieldbus segment length max.	1000 m
Transmission medium (communication/fieldbus)	Shielded Cu cable 3 x 0.25 mm <sup>2</sup>
Number of fieldbus nodes on the master max.	110
Program memory	640 kByte
Data memory	832 kByte
Software non-volatile memory	8 Kbytes
Memory for fieldbus input variables max.	512 Byte
Memory for fieldbus output variables max.	512 Byte
Number of modules per node max.	64
No. of PDOs	32 Tx / 32 Rx
No. of SDOs	2 server SDOs / 16 client SDOs
Input and output process image (Fieldbus) max.	512 Byte/512 Byte
Other CANopen features	NMT slave Minimum boot-up Variable PDO mapping Emergency message Life guarding / heartbeat Configuration of virtual modules
COB ID distribution	SDO, standard
Node ID distribution	DIP switches
Profiles supported	Communication profile: DS-301 V4.01; device profile: DS-401 V2.0; limit monitoring, flank-triggered PDOs, configurable response in the event of an error, DSP 405, NMT master programmable using function blocks
Indicators	LED (STOP) red: Device/node Stop; LED (RUN) green: Initialization; LED (TX, RX OVERFLOW) red: CAN send/receive buffer overflow; LED (I/O, USR) red/green/orange: Internal data bus status, status programmable by user; LED (A, B) green: System power supply status, field supply



System supply voltage	DC 24 V(-25 ... +30 %); via wiring level (CAGE CLAMP® connection)
Input current typ. at rated load (24 V)	500 mA
Efficiency of the power supply (typ.) at nominal load (24 V)	87 %
Current consumption, system supply (5 V)	350 mA
Total current for system supply	1650 mA
Field supply voltage	DC 24 V (-25 ... +30 %); via power jumper contacts
Current carrying capacity of the power jumper contacts	10 A
Number of outgoing power jumper contacts	3
Isolation	500 V system/supply

### Connection data

Connection technology: communication/fieldbus	CANopen: 1 x D-Sub 9 connector
Connection technology: system supply	2 x CAGE CLAMP®
Connection technology: field supply	6 x CAGE CLAMP®
Connection type (1)	System/field supply
Solid conductor	0.08 ... 2.5 mm <sup>2</sup> / 28 ... 14 AWG
Fine-stranded conductor	0.08 ... 2.5 mm <sup>2</sup> / 28 ... 14 AWG
Strip length	8 ... 9 mm / 0.31 ... 0.35 inch
Connection technology: Device configuration	1 x 4-pole male connector

### Geometrical Data

Width	50.5 mm / 1.988 inch
Height	71.1 mm / 2.799 inch
Height from upper-edge of DIN-35 rail	63.9 mm / 2.516 inch
Depth	100 mm / 3.937 inch

### Mechanical data

Weight	182.5 g
Color	light gray
Housing material	Polycarbonate, polyamide 6.6
Conformity marking	1

### Environmental Requirements

Surrounding air (operating) temperature	0 ... 55 °C
Surrounding air (storage) temperature	-40 ... 85 °C
Protection class	IP20
Degree of pollution (5)	2 per IEC 61131-2
Operating altitude	without temperature derating: 0 ... 2000 m; with temperature derating: 2000 ... 5000 m (0.5 K/100 m); max.: 5000 m

Relative air humidity (no condensation)	95 %
Mounting position	any
Type of mounting	DIN-35 rail
Vibration resistance	4g per IEC 60068-2-6
Shock resistance	15g per IEC 60068-2-27
EMC immunity to interference	acc. to EN 61000-6-2, marine applications
EMC emission of interference	acc. to EN 61000-6-4, marine applications
Exposure to pollutants	Per IEC 60068-2-42 and IEC 60068-2-43
Permissible H <sub>2</sub> S contaminant concentration at a relative humidity 75 %	10 ppm
Permissible SO <sub>2</sub> contaminant concentration at a relative humidity 75 %	25 ppm

### Commercial data

Product Group	15 (Remote I/O)
Country of origin	DE
GTIN	4050821072874
Customs Tariff No.	85371091990

### Approvals / Certificates

#### Ex-Approvals

Logo	Approval	Additional Approval Text	Certificate name
	UL Underwriters Laboratories Inc. (HAZARDOUS LOCATIONS)	ANSI/ISA 12.12.01	E198726 Sec.1

#### Country specific Approvals

Logo	Approval	Additional Approval Text	Certificate name
	KC National Radio Research Agency	Article 58-2, Clause 3	MSIP- REM-W43- PFC750

#### Ship Approvals

Logo	Approval	Additional Approval Text	Certificate name
	ABS American Bureau of Shipping	-	19- HG1821926



**DNV GL**  
Det Norske Veritas, Germanischer Lloyd

-

TAA0000194



**LR**  
Lloyds Register

-

02/20026  
(E5)

**PRS**  
Polski Rejestr Statków

-







TE/2236  
/880590/19

### UL-Approvals

















Logo	Approval	Additional Approval Text	Certificate name
	<b>UL</b> UL International Netherlands B.V. (ORDINARY LOCATIONS)	UL 508	E175199 Sec.1

### Compatible products

#### shield connection

	<b>Item no.: 790-108</b> Shield clamping saddle; 11 mm wide; diameter of compatible conductor	790-108
	<b>Item no.: 790-116</b> Shield clamping saddle; 19 mm wide; diameter of compatible conductor; 7 ... 16 mm	790-116
	<b>Item no.: 790-124</b> Shield clamping saddle; 27 mm wide; diameter of compatible conductor; 6 ... 24 mm	790-124
	<b>Item no.: 790-140</b> Shield clamping saddle; diameter of compatible conductor	790-140
	<b>Item no.: 790-208</b> Shield clamping saddle; 12.4 mm wide; 3 ... 8 mm	790-208
	<b>Item no.: 790-216</b> Shield clamping saddle; 21.8 mm wide; 6 ... 16 mm	790-216
	<b>Item no.: 790-220</b> Shield clamping saddle; 30 mm wide; 6 ... 20 mm	790-220

#### system box

	<b>Item no.: 850-804</b> IP65 enclosure; Stainless steel; WxHxD (400x123x200 mm); 4 x M20, 16 x M16, 28 x M12 cable grip		850-804
	<b>Item no.: 850-804/000-001</b> IP65 enclosure; Stainless steel; WxHxD (400x123x200 mm); 2 x M20, 13 x M16, 32 x M12 cable grip	/000-001	850-804
	<b>Item no.: 850-805</b> IP65 enclosure; Stainless steel; WxHxD (600x123x200 mm); 4 x M20, 19 x M16, 67 x M12 cable grip		850-805
	<b>Item no.: 850-814/002-000</b> IP65 enclosure; Sheet steel (RAL 7035); WxHxD (200x120x200 mm); without flange plate	/002-000	850-814
	<b>Item no.: 850-815/002-000</b> IP65 enclosure; Sheet steel (RAL 7035); WxHxD (300x120x200 mm); without flange plate	/002-000	850-815
	<b>Item no.: 850-816/002-000</b> IP65 enclosure; Sheet steel (RAL 7035); WxHxD (400x120x200 mm); without flange plate	/002-000	850-816
	<b>Item no.: 850-817/002-000</b> IP65 enclosure; Sheet steel (RAL 7035); WxHxD (600x120x200 mm); without flange plate	/002-000	850-817
	<b>Item no.: 850-825</b> IP65 enclosure; Aluminium (RAL 7032); WxHxD (160x100x160 mm); 9 x M12, 4 x M20		850-825
	<b>Item no.: 850-826</b> IP65 enclosure; Aluminium (RAL 7032); WxHxD (240x100x160 mm); 4 x M20, 4 x M16, 14 x M12 cable grip		850-826
	<b>Item no.: 850-826/002-000</b> IP65 enclosure; Aluminium (RAL 7035); WxHxD (240x100x160 mm); 4 x M20, 4 x M16, 14 x M12 cable grip	/002-000	850-826
	<b>Item no.: 850-827</b> IP65 enclosure; Aluminium (RAL 7032); WxHxD (320x100x160 mm); 4 x M20, 8 x M16, 17 x M12 cable grip		850-827
	<b>Item no.: 850-827/002-000</b> IP65 enclosure; Aluminium (RAL 7035); WxHxD (320x100x160 mm); 4 x M20, 8 x M16, 17 x M12 cable grip	/002-000	850-827
	<b>Item no.: 850-828</b> IP65 enclosure; Aluminium (RAL 7032); WxHxD (480x100x160 mm); 4 x M20, 10 x M16, 35 x M12 cable grip		850-828
	<b>Item no.: 850-828/002-000</b> IP65 enclosure; Aluminium (RAL 7035); WxHxD (480x100x160 mm); 4 x M20, 10 x M16, 35 x M12 cable grip	/002-000	850-828
	<b>Item no.: 850-834</b> IP65 enclosure; Polyester (RAL 7032); WxHxD (164x100x164 mm); 9 x M12, 4 x M20		850-834
	<b>Item no.: 850-835</b> IP65 enclosure; Polyester (RAL 7032); WxHxD (244x100x164 mm); 4 x M20, 4 x M16, 14 x M12 cable grip		850-835
	<b>Item no.: 850-836</b>		



IP65 enclosure; Polyester (RAL 7032); WxHxD (324x100x164 mm); 4 x M20, 8 x M16, 17 x M12 cable grip

850-836

#### Carrier rail



**Item no.: 210-112**

Steel carrier rail; 35 x 7.5 mm; 1 mm thick; 2 m long; slotted; according to EN 60715; "Hole width 25 mm

210-112



**Item no.: 210-113**

Steel carrier rail; 35 x 7.5 mm; 1 mm thick; 2 m long; unslotted; according to EN 60715

210-113



**Item no.: 210-114**

Steel carrier rail; 35 x 15 mm; 1.5 mm thick; 2 m long; unslotted; similar to EN 60715

210-114



**Item no.: 210-115**

Steel carrier rail; 35 x 7.5 mm; 1 mm thick; 2 m long; slotted; according to EN 60715; "Hole width 18 mm

210-115



**Item no.: 210-118**

Steel carrier rail; 35 x 15 mm; 2.3 mm thick; 2 m long; unslotted; according to EN 60715

210-118



**Item no.: 210-196**

Aluminum carrier rail; 35 x 8.2 mm; 1.6 mm thick; 2 m long; unslotted; similar to EN 60715

210-196



**Item no.: 210-197**

Steel carrier rail; 35 x 15 mm; 1.5 mm thick; 2 m long; slotted; similar to EN 60715

210-197



**Item no.: 210-198**

Copper carrier rail; 35 x 15 mm; 2.3 mm thick; 2 m long; unslotted; according to EN 60715

210-198



**Item no.: 210-504**

Steel carrier rail; 35 x 7.5 mm; 1 mm thick; 2 m long; slotted; galvanized; according to EN 60715

210-504



**Item no.: 210-505**

Steel carrier rail; 35 x 7.5 mm; 1 mm thick; 2 m long; unslotted; galvanized; according to EN 60715

210-505



**Item no.: 210-506**

Steel carrier rail; 35 x 15 mm; 1.5 mm thick; 2 m long; unslotted; galvanized; similar to EN 60715

210-506



**Item no.: 210-508**

Steel carrier rail; 35 x 15 mm; 1.5 mm thick; 2 m long; slotted; galvanized; similar to EN 60715

210-508

#### Marking accessories



**Item no.: 2009-145**

Mini-WSB Inline; for Smart Printer; on reel; stretchable 5 - 5.2 mm; plain; snap-on type

2009-145



**Item no.: 2009-145/000-002**

Mini-WSB Inline; for Smart Printer; on reel; stretchable 5 - 5.2 mm; plain; snap-on type

2009-145

/000-002



**Item no.: 2009-145/000-005**

Mini-WSB Inline; for Smart Printer; on reel; stretchable 5 - 5.2 mm; plain; snap-on type

2009-145

/000-005



**Item no.: 2009-145/000-006**

Mini-WSB Inline; for Smart Printer; on reel; stretchable 5 - 5.2 mm; plain; snap-on type

2009-145

/000-006

























**Item no.: 2009-145/000-007**

Mini-WSB Inline; for Smart Printer; on reel; stretchable 5 - 5.2 mm; plain; snap-on type

2009-145

/000-007

	<b>Item no.: 2009-145/000-012</b> Mini-WSB Inline; for Smart Printer; on reel; stretchable 5 - 5.2 mm; plain; snap-on type	/000-012	2009-145
	<b>Item no.: 2009-145/000-023</b> Mini-WSB Inline; for smartPRINTER; on reel; stretchable 5 - 5.2 mm; plain; snap-on type	/000-023	2009-145
	<b>Item no.: 2009-145/000-024</b> Mini-WSB Inline; for Smart Printer; on reel; stretchable 5 - 5.2 mm; plain; snap-on type	/000-024	2009-145
	<b>Item no.: 248-501</b> Miniature WSB Quick marking system; plain; Marker width 5 mm; 10 strips with 10 markers per card		248-501
	<b>Item no.: 248-501/000-002</b> Mini-WSB marking card; as card; not stretchable; plain; snap-on type	/000-002	248-501
	<b>Item no.: 248-501/000-005</b> Mini-WSB marking card; as card; not stretchable; plain; snap-on type	/000-005	248-501
	<b>Item no.: 248-501/000-006</b> Mini-WSB marking card; as card; not stretchable; plain; snap-on type	/000-006	248-501
	<b>Item no.: 248-501/000-007</b> Mini-WSB marking card; as card; not stretchable; plain; snap-on type	/000-007	248-501
	<b>Item no.: 248-501/000-012</b> Mini-WSB marking card; as card; not stretchable; plain; snap-on type	/000-012	248-501
	<b>Item no.: 248-501/000-017</b> Mini-WSB marking card; as card; not stretchable; plain; snap-on type	/000-017	248-501
	<b>Item no.: 248-501/000-023</b> Mini-WSB marking card; as card; not stretchable; plain; snap-on type	/000-023	248-501
	<b>Item no.: 248-501/000-024</b> Mini-WSB marking card; as card; not stretchable; plain; snap-on type	/000-024	248-501
	<b>Item no.: 750-100</b> Marker card; as a DIN A4 sheet; plain		750-100
	<b>Item no.: 750-103</b> Group marker carrier		750-103
	<b>Item no.: 750-106</b> Group marker carrier		750-106
<b>software</b>			
	<b>Item no.: 759-333</b>		

	WAGO-I/O-PRO			759-333
	Item no.: 759-333/000-923 WAGO-I/O-PRO; USB-Set		759-333	759-333 759-333
	Item no.: 759-911 WAGO-I/O-PRO; CD			759-911
<b>General accessories</b>				
	Item no.: 750-921 Bluetooth® Adapter			750-921
	Item no.: 750-923 Configuration cable; USB connector; Length: 2.5 m			750-923
	Item no.: 750-923/000-001 Configuration cable; USB connector; Length: 5 m			750-923 750-923
<b>wiring and connectors</b>				
	Item no.: 750-963 Fieldbus Connector CANopen; with D-sub female connector; 9-pole			750-963

**Downloads**

**Documentation**

<b>Manual</b>				
Programmable Fieldbus Controller CANopen, D-SUB 16-bit CPU		V 2.1.0	pdf 7.9 MB	Download
<b>Bid Text</b>				
750-838/021-000 IO, Controller		Oct 2, 2014	doc 30.7 kB	Download
<b>Additional Information</b>				
Disposal; Electrical and electronic equipment, Packaging		V 1.0.0	pdf 265.8 kB	Download
<b>System Description</b>				
750 Controller, General Product Information			pdf 621.9 kB	Download
Design Notes Basic conditions and recommendations for higher operational safety		V 2.0.0	pdf 1.5 MB	Download
Overview on WAGO-I/O-SYSTEM 750 approvals			pdf 780.2 kB	Download



Use in Hazardous Environments Term definition, marking and installation regulations	V 1.0.0	pdf 1.0 MB	Download
--	---------	---------------	----------

---

## Engineering-Software

### Configuration and Commissioning Software

WAGO-IO-PRO Demo-Version (759-912) / Serie 750, 758 und 762	2.3.9.55 Jul 3, 2015	zip 108.3 MB	Download
WAGO Extension Setting / 750 Series	2.0.2 Mar 9, 2011	zip 5.4 MB	Download

---

## Runtime Software

### Firmware

Firmware: 750-838/021-000 Controller CANopen; 640/832 KB Program/RAM; D-Sub 17	17 Feb 26, 2018	zip 712.6 kB	Download
--	--------------------	-----------------	----------

---

## CAD/CAE - Smart Data

### CAD data

3D Download 750-838/021-000		URL	Download
-----------------------------	--	-----	----------

---

## Device Files

### Device Description File

750-914; EDS file for CANopen / 750, 752 and 767 Series	XQ Dec 1, 2015	zip 1.7 MB	Download
---	-------------------	---------------	----------

---

### Device Driver

WAGO USB Service Cable Driver / 750 and 857 Series 759-923	6.5.3.0 Sep 10, 2014	zip 4.8 MB	Download
---	-------------------------	---------------	----------

---



## Product family

### Controller 750

[Learn more about the product family.](#)

[Show all products from the family](#)

Subject to changes.

---